

# POOL IDENTIFICATION AND PARTS ORDER FORM

313 Regina Avenue, Rahway, New Jersey 07065  
 Phone: (732) 574-1500 • Fax: (732) 574-1551  
 www.swimnplay.com • E-mail: info@swimnplay.com



Please fill out to the best of your ability and return to the address above. Attach a photograph if possible. Once we receive the form we will process your order and contact you with pricing information.

Name \_\_\_\_\_  
 Address \_\_\_\_\_  
 \_\_\_\_\_  
 Phone \_\_\_\_\_  
 E-mail \_\_\_\_\_

Approximate year of pool purchase \_\_\_\_\_  
 Size of pool \_\_\_\_\_  
 Frame Style  
 (From Following Pages)  
 \_\_\_\_\_  
 Pool Type From Below  
 \_\_\_\_\_

## PARTS NEEDED

Qty	Description	Length	Color	Material (Steel, Aluminum, Resin)

## POOL TYPE

### ROUND POOLS

### OVAL POOLS











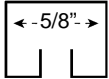



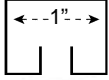

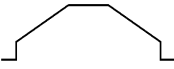

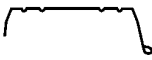



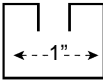

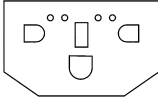
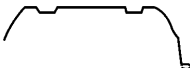



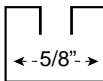

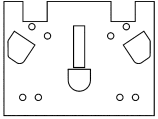

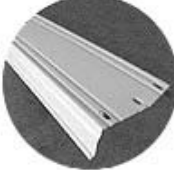
#### STANDARD

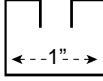
#### POLE

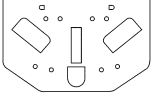
#### SLIM STYLE

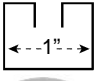
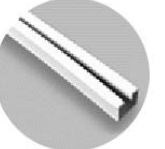

# FRAME STYLES

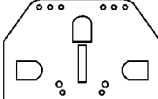
	Ledge	Vertical	Rail	Cover	Plate
<b>5/8" POOL FRAME</b>  <b>1A</b>	 	 	N/A	N/A	N/A
<b>1" POOL FRAME</b>  <b>1B</b>	 	 	N/A		N/A
<b>4" POOL FRAME</b>  <b>4A</b>	 	 	 		
<b>6" POOL FRAME (Princeton)</b>  <b>6A</b>	 	 	 		
<b>6" POOL FRAME (Omni)</b>  <b>6B</b>	 	 	 		
<b>6" DELUXE FRAME (Stockbridge)</b>  <b>6C</b>	 	 	 		

# FRAME STYLES

**6" EXTRUDED ALUMINUM FRAME (Essex)**

**6D**

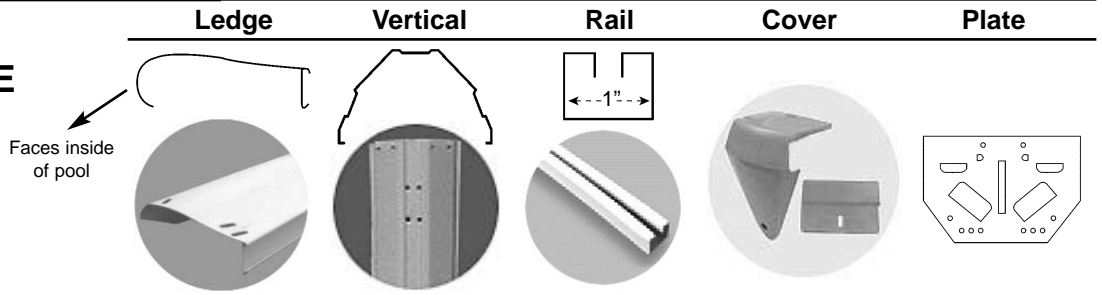

**6" EXTRUDED ALUMINUM FRAME (Alexis)**

**6E**

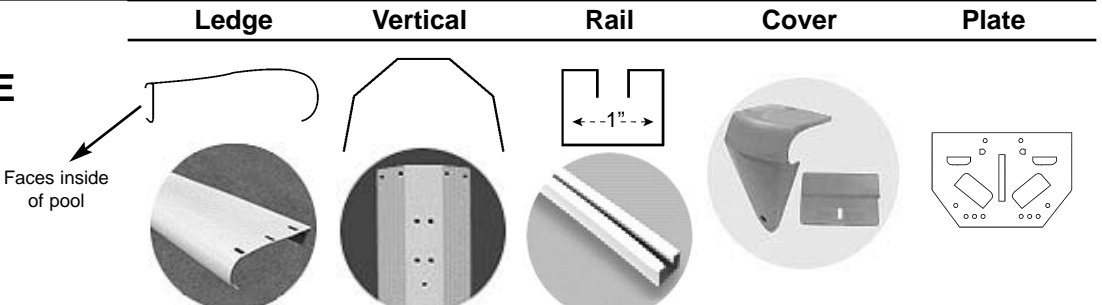

**7" XL POOL FRAME**

**7A**

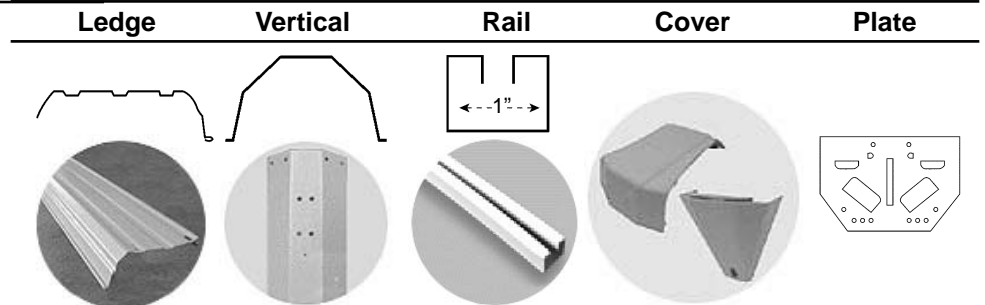

**7" XL POOL FRAME (Oasis)**

**7A-1**

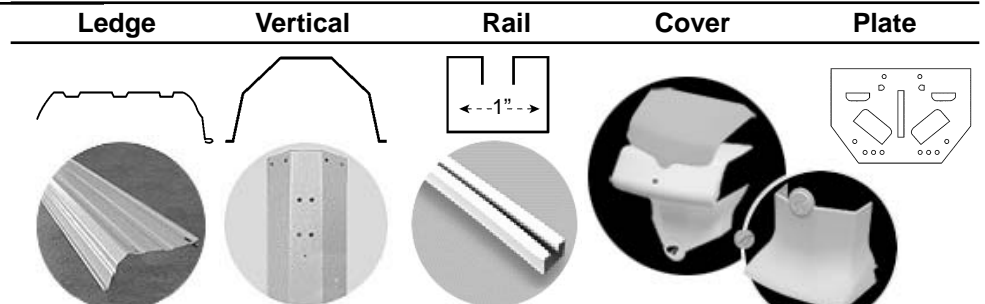

**7" POOL FRAME**

**7B**

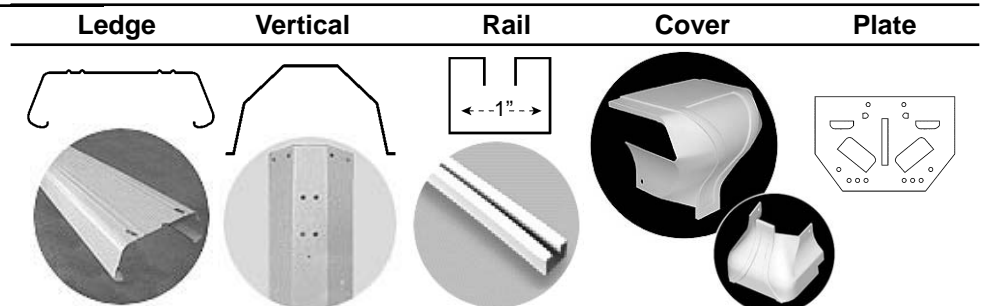

**7" POOL FRAME (Palisades)**

**7C**

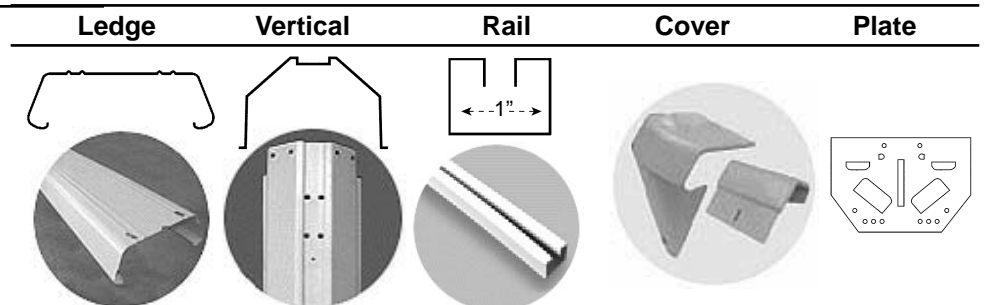

# FRAME STYLES

## 7" EXTRUDED RESIN FRAME

**7D**

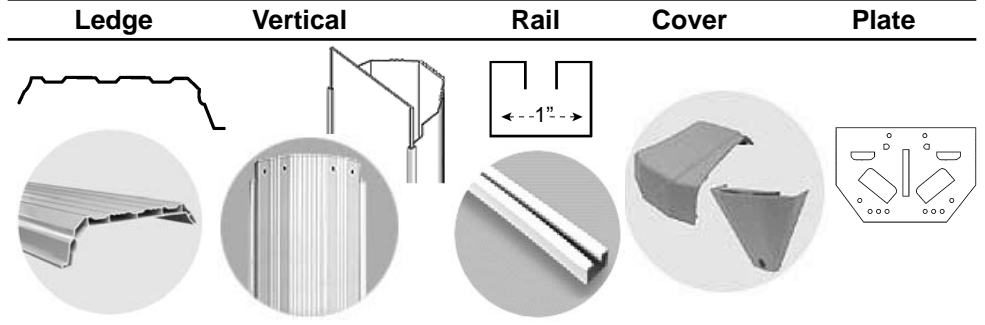

## 9" POOL FRAME

**9A**

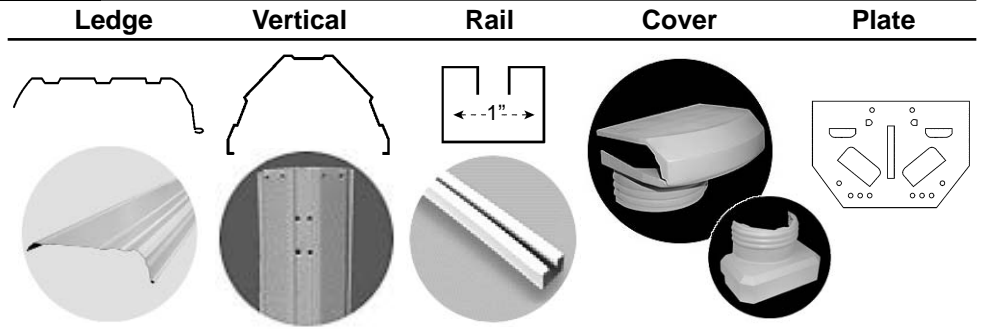

## 9" POOL FRAME (Royal Admiral)

**9B**

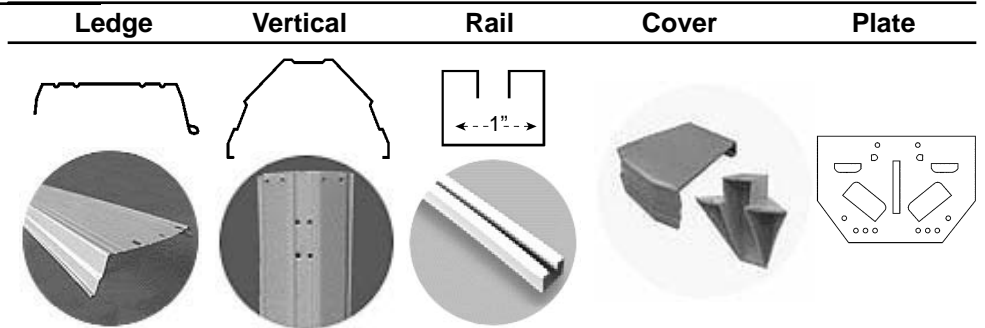

To measure the rails:

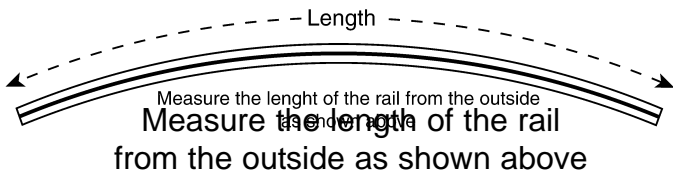

To measure the ledges:

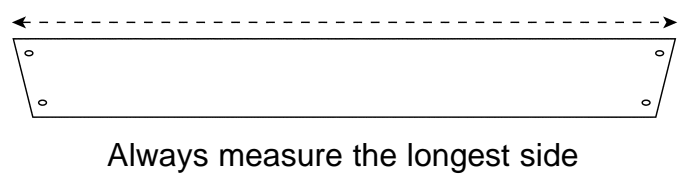

To measure the buttresses:

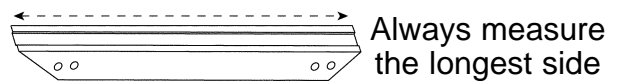

### 1995 and After

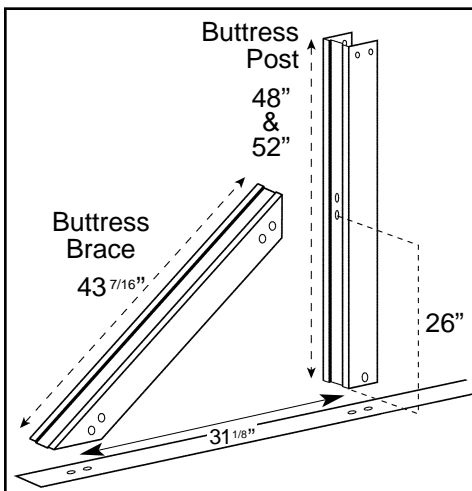

All 1995 and after buttress braces fit both 52" and 48" oval pools.

### 1994 and Prior

