











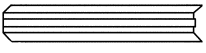



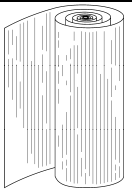
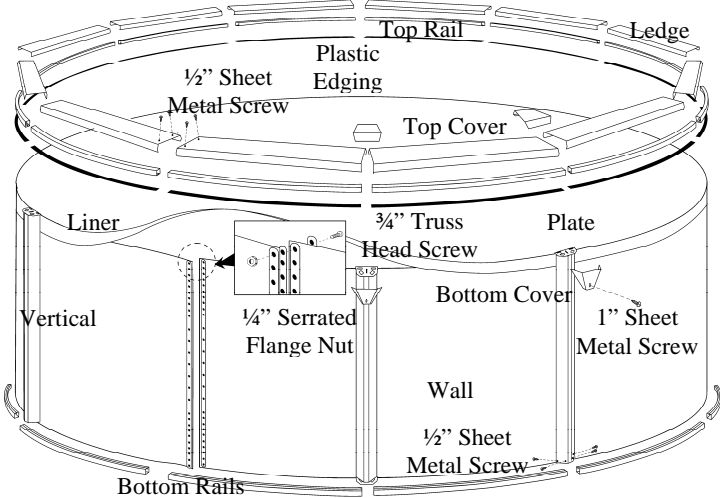

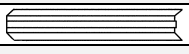





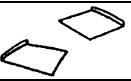

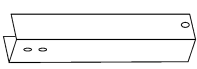
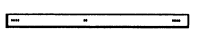
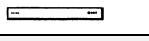
ITEM	DESCRIPTION	PART #	8'	12'	15'	18'	21'	24'	27'	30'	33'
Pool Hardware											
	1/4" Stainless S. Cage Nut	460170	9	10	10	12	14	16	18	20	22
	#12x1/2" SS Sheet Metal Screw	460218	144	160	160	192	224	256	288	320	352
	3/4" Screw For Top Cover	460118	9	10	10	12	14	16	18	20	22
Carton # 4 - Verticals											
	51 5/8" Graphite Krystal Vertical	242150	9	10	10	12	14	16	18	20	22
Carton # 5 - Ledges											
	35 3/8" Graphite Ledge	242173	7								
	44 1/4" Graphite Ledge	242174	-	7	-	-	-	-	-	-	-
	55 5/8" Graphite Ledge	242177	-	-	7	9	11	13	15	17	19
	35 3/8" Graphite w/"DO NOT DIVE" Label	242173BL	1	-	-	-	-	-	-	-	-
	44 1/4" Graphite w/"DO NOT DIVE" Label	242174BL	-	1	-	-	-	-	-	-	-
	55 5/8" Graphite w/"DO NOT DIVE" Label	242177BL	-	-	1	1	1	1	1	1	1
	35 3/8" Graphite w/"DO NOT DIVE" Label	242173SL	1	-	-	-	-	-	-	-	-
	44 1/4" Graphite w/"DO NOT DIVE" Label	242174SL	-	2	-	-	-	-	-	-	-
	55 5/8" Graphite w/"DO NOT DIVE" Label	242177SL	-	-	2	2	2	2	2	2	2
Carton # 6											
	33'x52" Graphite Storm	123002	-	-	-	-	-	-	-	-	1
	Wall Hardware										
	3/8"- 16 X 3/4" Bolt	460222	-	-	-	-	-	-	-	-	23
	3/8"x1-7/8" Washer	460223	-	-	-	-	-	-	-	-	46
	3/8-16" Nut	460217	-	-	-	-	-	-	-	-	23
<p>Warning!</p> <p>Pools are not designed for Diving or Jumping!</p> <p>Diving or Jumping into an Above Ground Pool may result in Death or Serious Permanent Injury!</p>											
 <p>DANGER NO DIVING • SHALLOW WATER DIVING MAY CAUSE DEATH OR PERMANENT INJURY <small>DO NOT OFFICE COVER, OR PART OVER THIS SIDE</small></p>											

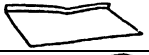

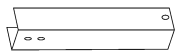
ITEM	DESCRIPTION	PART #	18 x 12	24 x 12	24 x 15	30 x 15	33 x 18	45 x 18
Carton 1								
	18'x12' Graphite Storm Wall	123003	1	-	-	-	-	-
	24'x12' Graphite Storm Wall	123004	-	1	-	-	-	-
	24'x15' Graphite Storm Wall	123005	-	-	1	-	-	-
	30'x15' Graphite Storm Wall	123006	-	-	-	1	-	-
	33'x18' Graphite Storm Wall	123007	-	-	-	-	1	-
	45'x18' Graphite Storm Wall	123008	-	-	-	-	-	1
Wall Hardware								
	3/8"-16x3/4" Truss Head Screw	460222	23	23	23	23	23	23
	3/8"x1-7/8" Washer	460223	46	46	46	46	46	46
	3/8"-16 Serrated Flange Nut	460217	23	23	23	23	23	23
Carton 2								
	Liner (Not Supplied by Manufacture)	999999	1	1	1	1	1	1
Carton 3								
	Graphite Top Cover	361R69	14	16	16	18	20	26
	Gray Wrap Outside Cover	361866	10	10	10	10	12	12
	Gray Foot Cover	361867	10	10	10	10	12	12
	Gray Wrap Buttress Cover	361868	4	6	6	8	8	14
	Graphite Splash Insert	361R70	24	26	26	28	32	38
	Gray Splash Holder	361871	4	6	6	8	8	14
	Buttress Top Plate	230460	4	6	6	8	8	14
	Buttress Brace Bracket	230335	8	12	12	16	16	28
	Top & Bottom Plate	230466	20	20	20	20	24	24
	31 1/4" Transition Steel Rails	241842	-	-	8	-	-	-
	31 1/2" Transition Steel Rails	241967	8	-	-	-	-	-
	43 5/16" Transition Steel Rails	241841	-	-	-	8	8	8
	43 1/2" Transition Steel Rails	241973	-	8	-	-	-	-
	43" Standard Steel Rails	240838	16	16	-	-	-	-
	54 5/16" Standard Steel Rails	240834	-	-	16	16	20	20
	45 1/2" Side Steel Rails	241840	4	8	8	12	12	24
	Plastic Edging	350008	16	20	21	25	28	36
	30 Year Limited Warranty	420446	1	1	1	1	1	1
	Instructions	420869	1	1	1	1	1	1
	Do Not Dive Label	490021	4	4	4	4	4	4
	Packing List	421000	1	1	1	1	1	1
	1/4" Stainless Steel Cage Nut	460170	14	16	16	18	20	26
	# 12 X 1/2" S.S. Metal Screw	460218	192	208	208	224	256	304
	# 10 X 1" S.S Metal Screw	460169	4	6	6	8	8	14
	3/4" Screw for Top Cover	460118	14	16	16	18	20	26
Support and Strap Hardware								
	1/4" X 2 3/4" S.S. Truss Head Bolt	460173	16	24	24	32	32	56
	1/4" S.S. Nut	460172	16	24	24	32	32	56
	5/16" X 3" Hex Head Bolt	460150	4	6	6	8	8	14
	5/16" X 3/4" Hex Head Bolt	460033	8	12	12	16	16	28
	5/16" X 1/2" Hex Head Bolt	460151	24	36	48	64	80	140
	5/16" Nut	460174	36	54	66	88	104	182
	5/16" Washer	460175	16	24	24	32	32	56

WARNING! POOLS ARE NOT DESIGNED FOR DIVING OR JUMPING!**Diving or jumping into an above ground pool may result in DEATH or serious PERMANENT injury!**

ITEM	DESCRIPTION	PART #	18 x 12	24 x 12	24 x 15	30 x 15	33 x 18	45 x 18
Carton 4								
	51 5/8" Graphite Vertical	242150	10	10	10	10	12	12
Carton 5								
	33 3/8" Graphite Ledge	242172	4	-	4	-	-	-
	44 1/4" Graphite Ledge	242174	5	5	-	-	-	-
	45 3/8" Graphite Ledge	242175	-	4	-	4	4	4
	47 1/2" Graphite Ledge	242176	-	2	2	4	4	4
	55 5/8" Graphite Ledge	242177	-	-	5	5	7	7
	44 1/4" Graphite Ledge w/ Do Not Dive Label	242174BL	1	1	-	-	-	-
	47 1/2" Graphite Ledge w/ Do Not Dive Label	242176BL	1	1	1	1	1	1
	55 5/8" Graphite Ledge w/ Do Not Dive Label	242177BL	-	-	1	1	1	1
	44 1/4" Graphite Ledge w/ Do Not Dive Label	242174SL	2	2	-	-	-	-
	47 1/2" Graphite Ledge w/ Do Not Dive Label	242176SL	1	1	1	1	1	1
	55 5/8" Graphite Ledge w/ Do Not Dive Label	242177SL	-	-	2	2	2	2
Carton 6								
	Buttress Bottom Plate	230338	4	6	6	8	8	8
	Hold down Sheet	230463	-	2	2	4	4	4
	Right Hold Down Sheet	230464	2	2	2	2	2	2
	Left Hold Down Sheet	230465	2	2	2	2	2	2
	Graphite Buttress Post	242170	4	6	6	8	8	8
	Graphite Buttress Brace	242169	4	6	6	8	8	8
	Inside Internal Upright	241984	-	2	2	4	4	4
	Outside Internal Upright	241985	4	4	4	4	4	4
Carton 7								
	Bottom Strap	180046	4	6	6	8	8	14
	Bottom Strap Extension 15-18	180044	-	-	3	4	8	14
Carton 8								
	47 1/2" Graphite Ledge	242176	-	-	-	-	-	6
Carton 9								
	Buttress Bottom Plate	230338	-	-	-	-	-	6
	Hold down Sheet	230463	-	-	-	-	-	6
	Graphite Buttress Post	242170	-	-	-	-	-	6
	Graphite Buttress Brace	242169	-	-	-	-	-	6
	Inside Internal Upright	241984	-	-	-	-	-	6
Carton 10								
	45'x18' Graphite Wall	123008	-	-	-	-	-	1
	3/8"-16 X 3/4" Truss Head Bolt	460222	-	-	-	-	-	23
	3/8" X 1-7/8" Washer	460223	-	-	-	-	-	46
	3/8"-16 Serrated Flange Nut	460217	-	-	-	-	-	23



NO DIVING • SHALLOW WATER
 DIVING MAY CAUSE DEATH OR PERMANENT INJURY



DO NOT DEFACE, COVER, OR PAINT OVER THIS SIGN

421000

WARNING! POOLS ARE NOT DESIGNED FOR DIVING OR JUMPING!
 Diving or jumping into an above ground pool may result in DEATH or serious PERMANENT injury!



ITEM	DESCRIPTION	PART #	18 x 12	24 x 12	24 x 15	30 x 15	33 x 18
Carton 1							
	18'x12' Graphite Storm Wall	123003	1	-	-	-	-
	24'x12' Graphite Storm Wall	123004	-	1	-	-	-
	24'x15' Graphite Storm Wall	123005	-	-	1	-	-
	30'x15' Graphite Storm Wall	123006	-	-	-	1	-
	33'x18' Graphite Storm Wall	123007	-	-	-	-	1
	Wall Hardware						
	3/8"-16 X 3/4" Truss Head Bolt	460222	23	23	23	23	23
	3/8" X 1-7/8" Washer	460223	46	46	46	46	46
	3/8"-16 Serrated Flange Nut	460217	23	23	23	23	23
Carton 2							
	Liner (Not Supplied by Manufacture)	999999	1	1	1	1	1
Carton 3							
	Graphite Wrap Cover Top	361R69	14	16	16	18	20
	Gray Wrap Cover Outside	361866	14	16	16	18	20
	Gray Foot Cover	361867	14	16	16	18	20
	Graphite Splash	261R70	28	32	32	36	40
	Non-Buttress Bottom Vertical Plate	230468	4	6	6	8	8
	Top & Bottom Plate	230466	24	26	26	28	32
	31 1/4" Transition Painted Steel Rails	241842	-	-	8	-	-
	31 1/2" Transition Painted Steel Rails	241967	8	-	-	-	-
	43 5/16" Transition Ptd Steel Rails	241841	-	-	-	8	8
	43 1/2" Transition Painted Steel Rails	241973	-	8	-	-	-
	43" Standard Painted Steel Rails	240838	16	16	-	-	-
	54 5/16" Standard Painted Steel Rails	230834	-	-	16	16	20
	42 1/4" Side Top Rails	241992	2	4	4	6	6
	45 1/2" Side Bottom Rails	241840	2	4	4	6	6
	Plastic Edging	350008	16	20	21	25	28
	30 Year Limited Warranty	420446	1	1	1	1	1
	Instructions	420745	1	1	1	1	1
	Do Not Dive Label	490870	4	4	4	4	4
	Packing List	421001	1	1	1	1	1
	# 12 X 1/2" S.S. Metal Screw	460218	168	192	192	246	240
	# 10 X 1" S.S. Metal Screw	460169	14	16	16	18	20
Support and Strap Hardware							
	# 12 X 1/2" Sheet Metal Screw	460199	8	12	12	16	16
	5/16" Hex Nut	460174	32	48	60	80	96
	5/16" X 1/2" Hex Head Bolt	460151	32	48	60	80	96
	3/8" -16 X 1 Hex Head Bolt	460216	72	104	104	136	136
	3/8" -16 Hex Nut	460217	72	104	104	136	136
Carton 4							
	51 5/8" Graphite Vertical	242150	14	16	16	18	20

WARNING! POOLS ARE NOT DESIGNED FOR DIVING OR JUMPING!

Diving or jumping into an above ground pool may result in DEATH or serious PERMANENT injury!



ITEM	DESCRIPTION	PART #	18 x 12	24 x 12	24 x 15	30 x 15	33 x 18
Carton 5							
	33 3/8" Graphite Ledge	242172	4	-	4	-	-
	45 3/8" Graphite Ledge	242175	-	4	-	4	4
	44 1/4" Graphite Ledge	242174	5	5	-	-	-
	47 1/2" Graphite Ledge	242176	-	2	2	4	4
	55 5/8" Graphite Ledge	242177	-	-	5	5	7
	44 1/4" Graphite Ledge w/ Do Not Dive Label	242174BL	1	1	-	-	-
	47 1/2" Graphite Ledge w/ Do Not Dive Label	242176BL	1	1	1	1	1
	55 5/8" Graphite Ledge w/ Do Not Dive Label	242177BL	-	-	1	1	1
	44 1/4" Gray Ledge w/ Do Not Dive Label	242174SL	2	2	-	-	-
	47 1/2" Gray Ledge w/ Do Not Dive Label	242176SL	1	1	1	1	1
	55 5/8" Gray Ledge w/ Do Not Dive Label	242177SL	-	-	2	2	2
Carton 6							
	T Plate	230461	8	12	12	8	8
	Hold Down Plate	230454	2	4	4	2	2
	Support Post	241979	4	6	6	4	4
	End Post Support	241980	4	4	4	4	4
	Bottom Support	241654	4	6	6	4	4
Carton 7							
	Bottom Strap 18 3/8"	180052	4	6	6	8	8
	Bottom Strap Extension 15-18	180044	-	-	3	4	8
Carton 8							
	T Plate	230461	-	-	-	8	8
	Hold Down Plate	230454	-	-	-	4	4
	Support Post	241979	-	-	-	4	4
	Bottom Support	241654	-	-	-	4	4

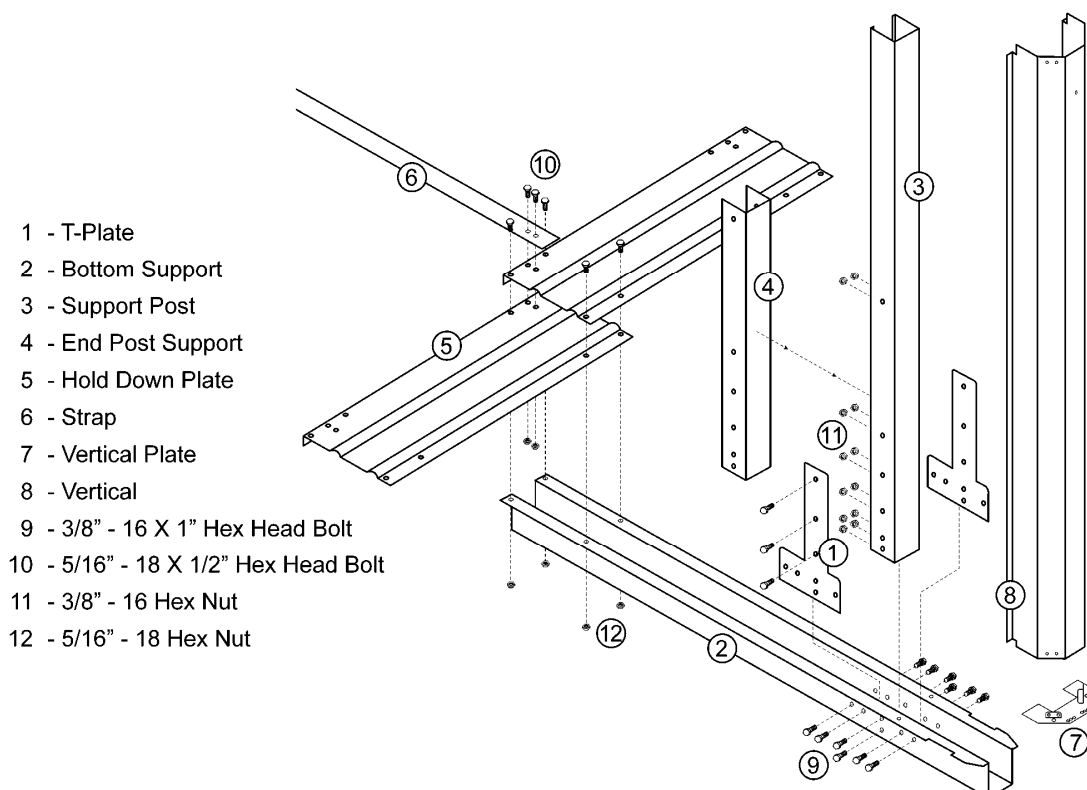

WARNING! POOLS ARE NOT DESIGNED FOR DIVING OR JUMPING!
 Diving or jumping into an above ground pool may result in DEATH or serious PERMANENT injury!